



SU-MO



SU-CL



SU-VA



SU-CU



SU-AB



SU-CA



CO-AR

### CARACTERISTICAS

- Sistemas de fijación rápida en perfiles y estructura metálica, sin taladrar ni soldar.
- Fijación rápida al golpear sobre el clip en los modelos SUCU, SUVA, SUCL y por roscado en el modelo SUMO.
- Amplio rango de modelos para todo tipo de perfiles.
- Valores altos de resistencia mecánica de los sistemas de suspensión.
- Apto para gran rango de espesores de perfiles estructurales.
- Empleo: fijación de falsos techos, sistemas con varilla roscada, fijación de tuberías con abrazaderas, etc.





















### MATERIAL BASE



### EJEMPLOS DE APLICACION



## 1. GAMA

ITEM	FOTO	REFERENCIA	DESCRIPCION	MATERIAL	RECUBRIMIENTO
1		SUMOP09	Mordaza para viga	 Acero	 Cincado $\geq 5\mu\text{m}$
		SUMOP11			
		SUMOP13			
		SUMOM06			
		SUMOM08			
		SUMOM10			
		SUMOM12			
2		SUCL02	Clip de suspensión	 Acero	 Fosfatado $\geq 5\mu\text{m}$
		SUCL04			
		SUCL10			
		SUCL15			
3		SUVA0602	Clip varilla	 Acero	 Fosfatado $\geq 5\mu\text{m}$
		SUVA0604			
		SUVA0610			
		SUVA0615			
		SUVA0802			
		SUVA0804			
		SUVA0810			
		SUVA0815			
4		SUCU0602	Clip de cuelgue	 Acero	 Fosfatado $\geq 5\mu\text{m}$
		SUCU0605			
		SUCU0606			
		SUCU0607			
5		SUAAB0603	Clip de viga para abrazadera	 Acero	 Fosfatado $\geq 5\mu\text{m}$
		SUAAB0607			
		SUAAB0614			
6		SUCA0602	Clip de viga para cable	 Acero	 Fosfatado $\geq 5\mu\text{m}$
		SUCA0604			
		SUCA0607			
		SUCA0802			
		SUCA0804			
		SUCA0807			
		SUCA1002			
		SUCA1004			
		SUCA1007			
		SUCA1202			
		SUCA1204			
		SUCA1207			
		SUCA1502			
		SUCA1504			
		SUCA1507			
		SUCA1902			
		SUCA1904			
SUCA1907					
SUCA2502					
SUCA2504					
SUCA2507					
7		COAR08060	Colgante articulado	 Acero	 Cincado $\geq 5\mu\text{m}$
		COAR10060			

## 2. DATOS DE INSTALACION

### 2.1 SU-MO

#### Mordaza para viga



Material

Recubrimiento



Acero

Cincado  $\geq 5\mu\text{m}$

#### Datos de Instalación

Código	A	B	C	D	E	Ø TALARO	TIPO DE INSTALACION	PAR DE INSTALACION
	[mm]	[mm]	[mm]	[mm]	[mm]	[mm]	[--]	[Nm]
SUMOP09	38	35	37	18	20	PASANTE 9	VARILLA ROSCADA + TUERCA O CABLE	10
SUMOP11	44	41	42	21	20	PASANTE 11		15
SUMOP13	57	48	54	24	25	PASANTE 13		20
SUMOM06	38	35	37	18	20	ROSCADO M6	VARILLA ROSCADA + TUERCA	10
SUMOM08	38	35	37	18	20	ROSCADO M8		10
SUMOM10	44	41	42	21	20	ROSCADO M10		15
SUMOM12	57	48	54	24	25	ROSCADO M12		20

#### Plano

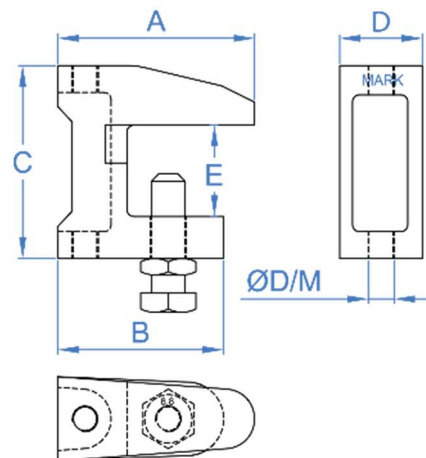

**2.2 SU-CL**

**Clip de suspensión**



**Material**



Acero

**Recubrimiento**



Fosfatado  $\geq 5\mu\text{m}$

**Datos de Instalación**

Código	A	B	C	Ø Agujero
	[mm]	[mm]	[mm]	[mm]
SUCL02	1,5 ÷ 4	28	14	6,3
SUCL04	4 ÷ 10	34	23	6,3
SUCL10	10 ÷ 15	40	23	6,3
SUCL15	15 ÷ 20	40	23	6,3

**Plano**

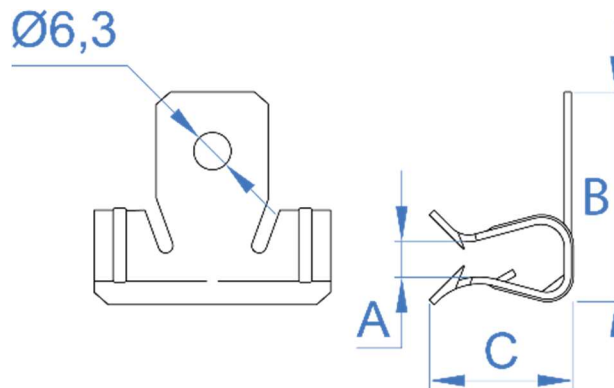

**2.3 SU-VA**

**Clip varilla**



**Material**



Acero

**Recubrimiento**



Fosfatado  $\geq 5\mu\text{m}$

**Datos de Instalación**

Código	A	B	C	W	Métrica (M)
	[mm]	[mm]	[mm]	[mm]	[mm]
SUVA0602	1,5 ÷ 4	50	14	28	M 6
SUVA0604	4 ÷ 10	54	23	40	M 6
SUVA0610	10 ÷ 15	60	23	40	M 6
SUVA0615	15 ÷ 20	60	23	40	M 6
SUVA0802	1,5 ÷ 4	50	14	28	M 8
SUVA0804	4 ÷ 10	54	23	40	M 8
SUVA0810	10 ÷ 15	60	23	40	M 8
SUVA0815	15 ÷ 20	60	23	40	M 8

**Plano**

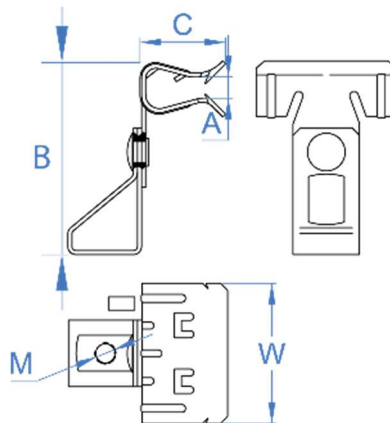

**2.4 SU-CL**

**Clip de cuelgue**



Material	Recubrimiento
	
Acero	Fosfatado $\geq 5\mu\text{m}$

**Datos de Instalación**

Código	A	B	C	Métrica (M)
	[mm]	[mm]	[mm]	[mm]
SUCU0602	1,5 ÷ 5	65	15	M 6
SUCU0605	5 ÷ 7	65	15	M 6
SUCU0606	3 ÷ 7	80	30	M 6
SUCU0607	7 ÷ 10	95	30	M 6

**Plano**

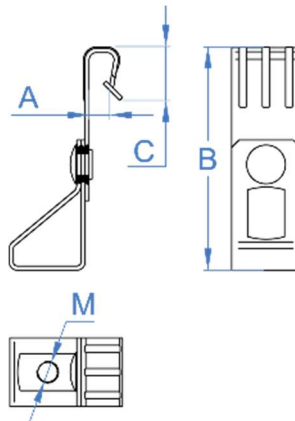

**2.5 SU-AB**

**Clip de viga para abrazadera**



Material	Recubrimiento
	
Acero	Fosfatado $\geq 5\mu\text{m}$

**Datos de Instalación**

Código	A	B	C	D	E	F	M1	M2	M3
	[mm]	[mm]	[mm]	[mm]	[mm]	[mm]	[mm]	[mm]	[mm]
SUAB0603	3 ÷ 7	30	36,5	33	45	15,4	M 6	M 6	M 6
SUAB0607	7 ÷ 13	36	36,5	33	45	15,4	M 6	M 6	M 6
SUAB0614	14 ÷ 20	43	36,5	33	45	15,4	M 6	M 6	M 6

**Plano**

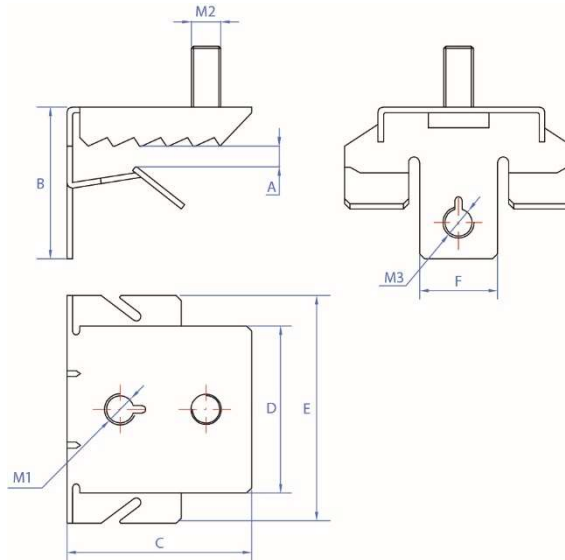

**2.6 SU-CA**

**Clip de viga para cable**



**Material**

**Recubrimiento**



Acier

Phosphate  $\geq 5\mu\text{m}$

**Datos de Instalación**

Código	A – Espesor	Diámetro de tubo	B	C	D	E	F
	[mm]	[mm]					
SUCA0602	1 - 4	6 - 7	0,6	14,0	5,8	3,8	4,8
SUCA0604	4 - 7,5	6 - 7					8,0
SUCA0607	7,2 - 12	6 - 7					12,0
SUCA0802	1 - 4	8 - 9			8,0	5,8	4,8
SUCA0804	4 - 7,5	8 - 9					8,0
SUCA0807	7,2 - 12	8 - 9					12,0
SUCA1002	1 - 4	10 - 11			9,7	6,8	4,8
SUCA1004	4 - 7,5	10 - 11					8,0
SUCA1007	7,2 - 12	10 - 11					12,0
SUCA1202	1 - 4	12 - 14			11,0	7,5	4,8
SUCA1204	4 - 7,5	12 - 14					8,0
SUCA1207	7,2 - 12	12 - 14					12,0
SUCA1502	1 - 4	15 - 18			13,5	9,0	4,8
SUCA1504	4 - 7,5	15 - 18					8,0
SUCA1507	7,2 - 12	15 - 18					12,0
SUCA1902	1 - 4	19 - 24			18,5	11,5	4,8
SUCA1904	4 - 7,5	19 - 24					8,0
SUCA1907	7,2 - 12	19 - 24					12,0
SUCA2502	1 - 4	25 - 30			24,6	19,5	4,8
SUCA2504	4 - 7,5	25 - 30					8,0
SUCA2507	7,2 - 12	25 - 30	12,0				

**Plan**

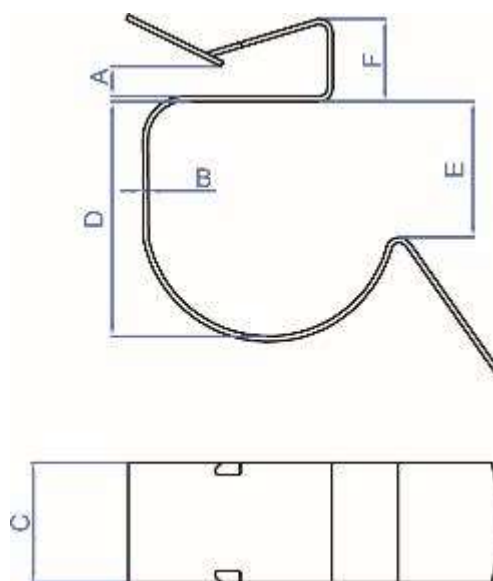



**2.7 CO-AR**

**Colgador articulado**



**Propiedades**



Acero



Recubrimiento cincado

**Dimensiones**

CODIGO	ØM (mm)	ØM1 (mm)	L1	Sw	Sw2
COAR08060	M8	M8	60	12,8 – 12,9	14,8 -14,9
COAR10060	M10	M10	61	16,8 – 16,9	16,8 – 16,9

**PLANO**

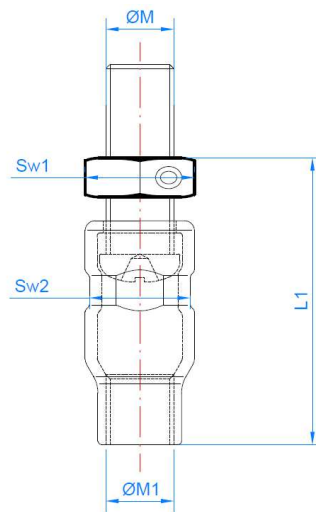







### 3. PROCESO DE INSTALACION

CODIGO	PASO 1	PASO 2	PASO 3	PASO 4	PASO 5
SU-MO					
	<b>Paso 1:</b> Posicionar la mordaza sobre el perfil, en el cual se quiera instalar.				
	<b>Paso 2:</b> Roscar el tornillo manualmente.				
	<b>Paso 3:</b> Con ayuda de una llave, apretar 1/2 vuelta el tornillo.				
	<b>Paso 4:</b> Roscar la contratuerca manualmente y apretar con una llave 1/8 de vuelta.				
<b>Paso 5:</b> Colocar el elemento de suspensión deseado.					
CODIGO	PASO 1	PASO 2	PASO 3		
SU-CL					
	<b>Paso 1:</b> Posicionar el clip sobre el perfil, en el cual se quiera instalar.				
	<b>Paso 2:</b> Golpear con un martillo el clip hasta que esté instalado completamente.				
<b>Paso 3:</b> Colocar el elemento de suspensión deseado.					
CODIGO	PASO 1	PASO 2	PASO 3		
SU-VA					
	<b>Paso 1:</b> Posicionar el clip sobre el perfil, en el cual se quiera instalar.				
	<b>Paso 2:</b> Golpear con un martillo el clip hasta que esté instalado completamente.				
<b>Paso 3:</b> Colocar el elemento de suspensión deseado.					
CODIGO	PASO 1	PASO 2	PASO 3		
SU-CU					
	<b>Paso 1:</b> Posicionar el clip sobre el perfil, en el cual se quiera instalar.				
	<b>Paso 2:</b> Golpear con un martillo el clip hasta que esté instalado completamente.				
<b>Paso 3:</b> Colocar el elemento de suspensión deseado.					

CODIGO	PASO 1	PASO 2	PASO 3	
SU-AB				
	<b>Paso 1:</b> Posicionar el clip sobre el perfil, en el cual se quiera instalar.			
	<b>Paso 2:</b> Golpear con un martillo el clip hasta que esté instalado completamente.			
	<b>Paso 3:</b> Colocar el elemento de suspensión deseado.			
CODIGO	PASO 1	PASO 2	PASO 3	PASO 4
SU-CA				
	<b>Paso 1:</b> Posicionar el clip sobre el perfil, en el cual se quiera instalar.			
	<b>Paso 2:</b> Golpear con un martillo el clip hasta que esté instalado completamente.			
	<b>Paso 3:</b> Presionar el clip hasta fijar el tubo			
<b>Paso 4:</b> Colocar el elemento de suspensión deseado.				

## 4. RESISTENCIAS

FOTO	CODIGO	CARGA MÁXIMA RECOMENDADA [kg]
	SUMOP09	120
	SUMOP11	250
	SUMOP13	350
	SUMOM06	120
	SUMOM08	120
	SUMOM10	250
	SUMOM12	350
	SUCL02	70
	SUCL04	
	SUCL10	
	SUCL15	
	SUVA0602	70
	SUVA0604	
	SUVA0610	
	SUVA0615	
	SUVA0802	
	SUVA0804	
	SUVA0810	
	SUVA0815	
	SUCU0602	70
	SUCU0605	
	SUCU0606	
	SUCU0607	
	SUAB0603	40
	SUAB0607	
	SUAB0614	
	COAR08060	120
	COAR10060	150